

Deckensysteme
KOMFORT WECHSELT PERSPEKTIVE



ClouTop®

ClouTop®



Vorteile der Deckenheizung und -kühlung

- Sehr gute Kühlleistung
- Eignet sich gut für den Heizbetrieb
- Schnelle Auf- und Abkühlzeiten
- Geeignet für Wohnbau
- Geeignet für Büroflächen

Anwendungsfall	α [W/m ² K]
Bodenheizung	10.8
Bodenkühlung	6.5
Wandheizung/-kühlung	8
Deckenheizung	6.5
Deckenkühlung	10.8

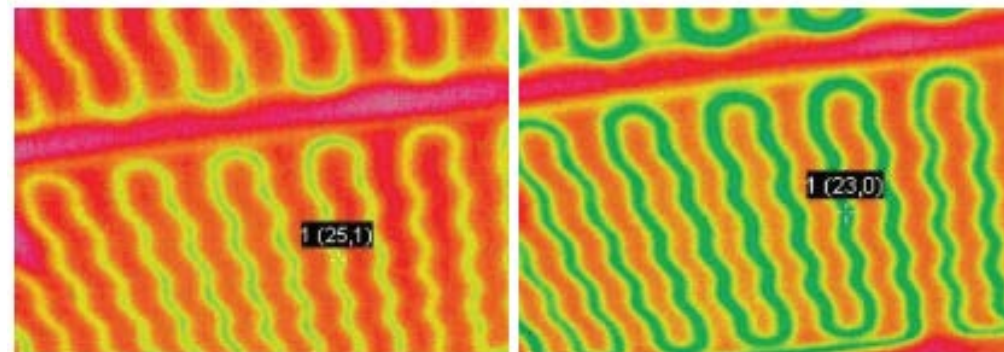

Nach 5 Minuten

Nach 20 Minuten

Vereinfachte Installation

- Patentierter “Aufweitungsstopfen” zur Verschließung und Aufweitung der Rohre;
- Anbindeleitungen 20x2 mm in der Systemplatte integriert;
- 10x1,3 mm Rohr im Gipskarton eingefräst.
- Lasermarkierung der Rohrführung für maximale Sicherheit bei der Montage

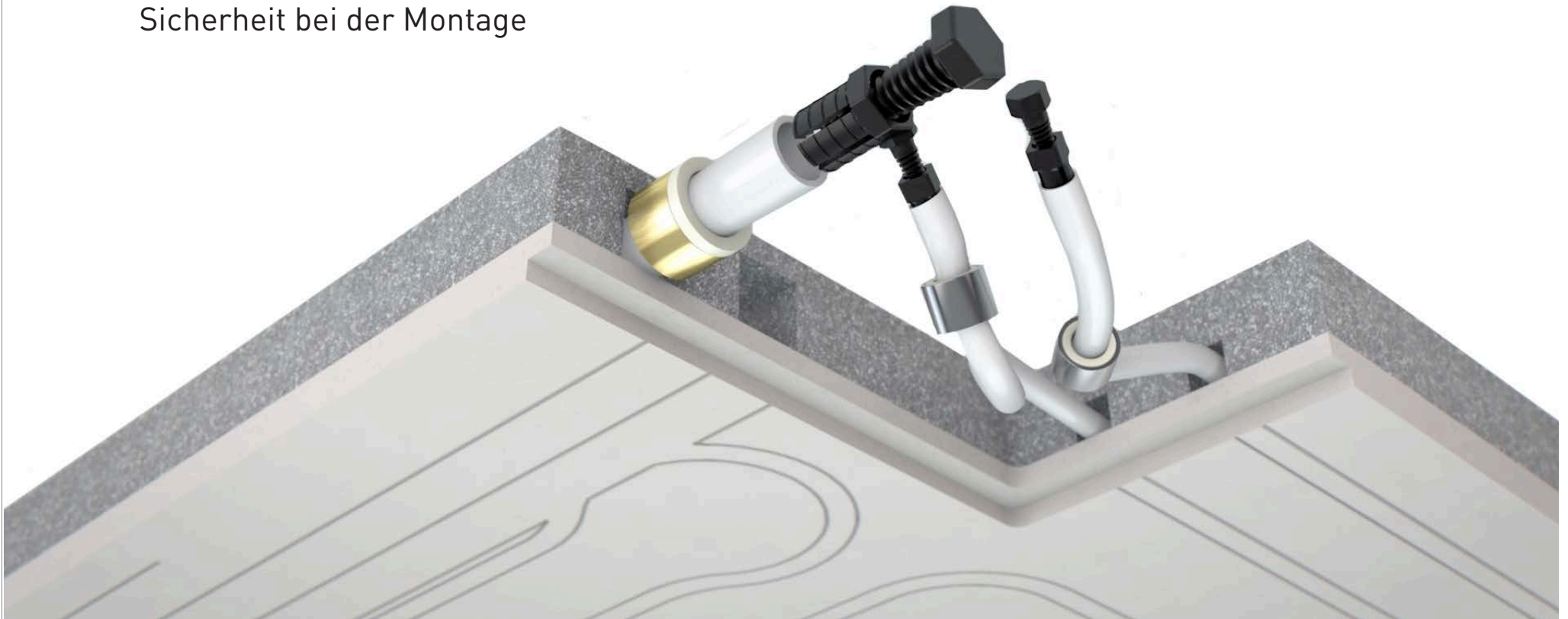

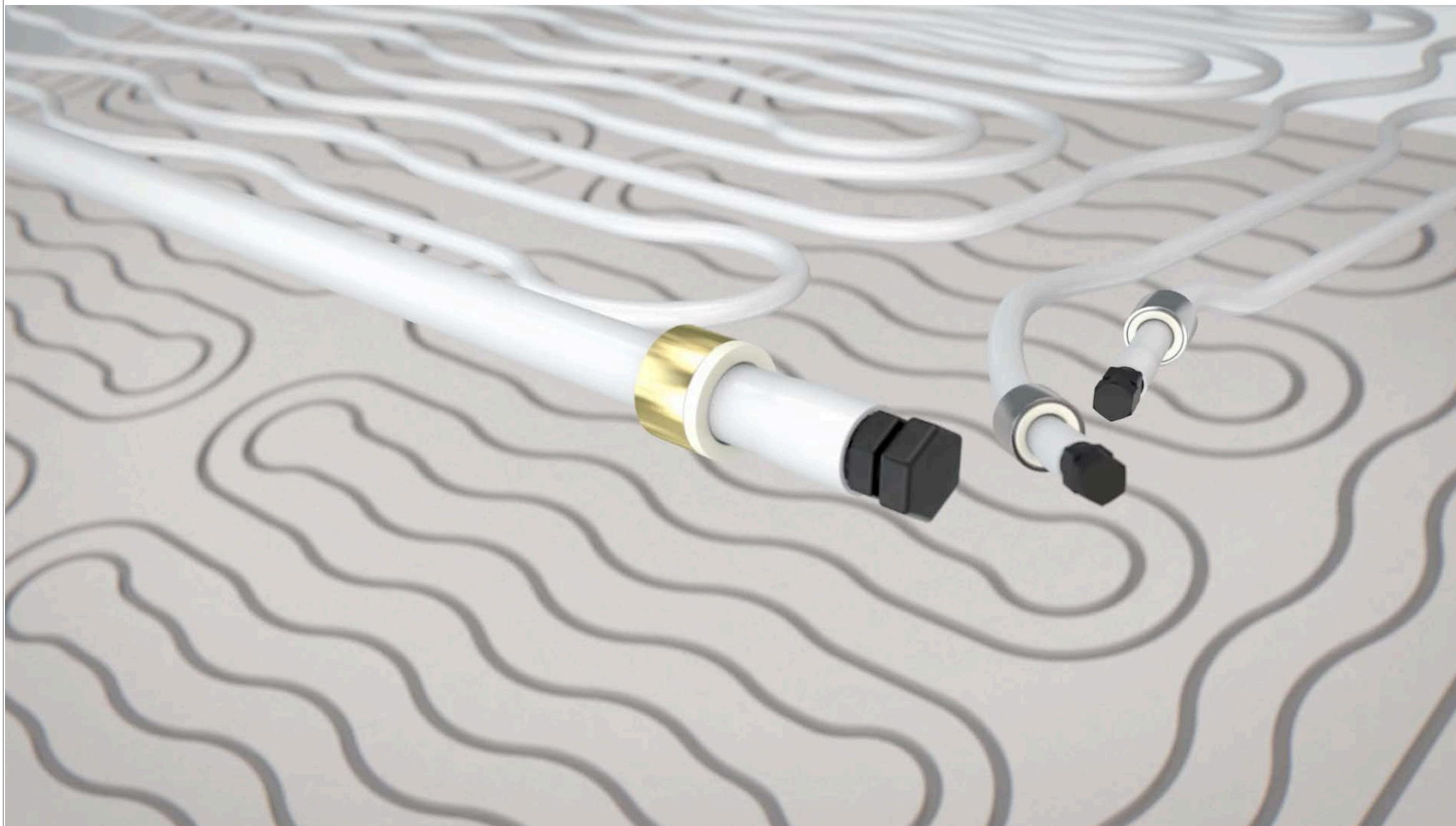

Vereinfachte Installation

- PPSU-Verbinder ohne O-Ringe
- Vereinfachte Montage durch vorgeweiteten Rohren
- Sofortige Überprüfung eventueller Leckagen

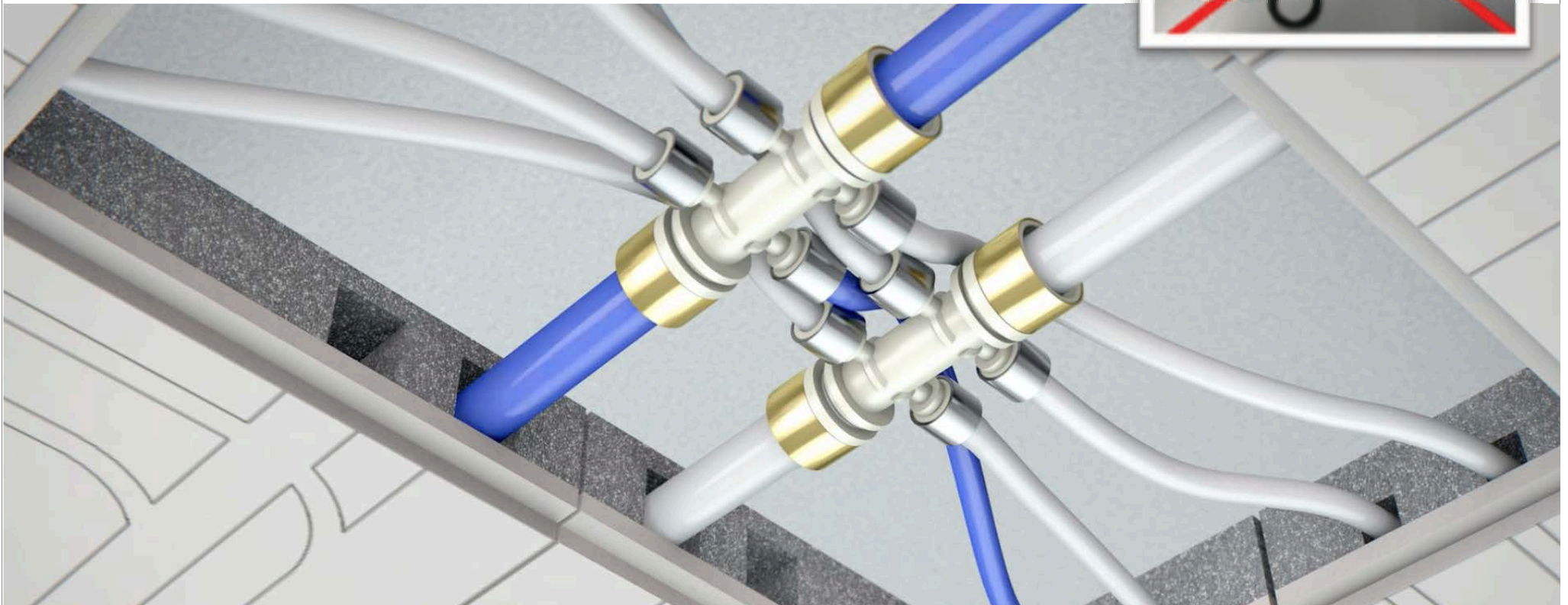

Rohr 10x1,3mm

Im Vergleich zu einem Rohr 8x1,1mm, welches in den herkömmlichen Deckensystemen verwendet wird, wurde im Deckensystem Leonardo ein Rohr 10x1,3mm verwendet. Das PE-RT Typ II Rohr, welches auch für Hochtemperatur Heizungen verwendet werden kann, hat 5 Schichten mit einer Sauerstoffsperre im Zentrum.



Rohr 8x1,1mm



Rohr 10x1,3mm

+25%

Integrierte Rohranbindung

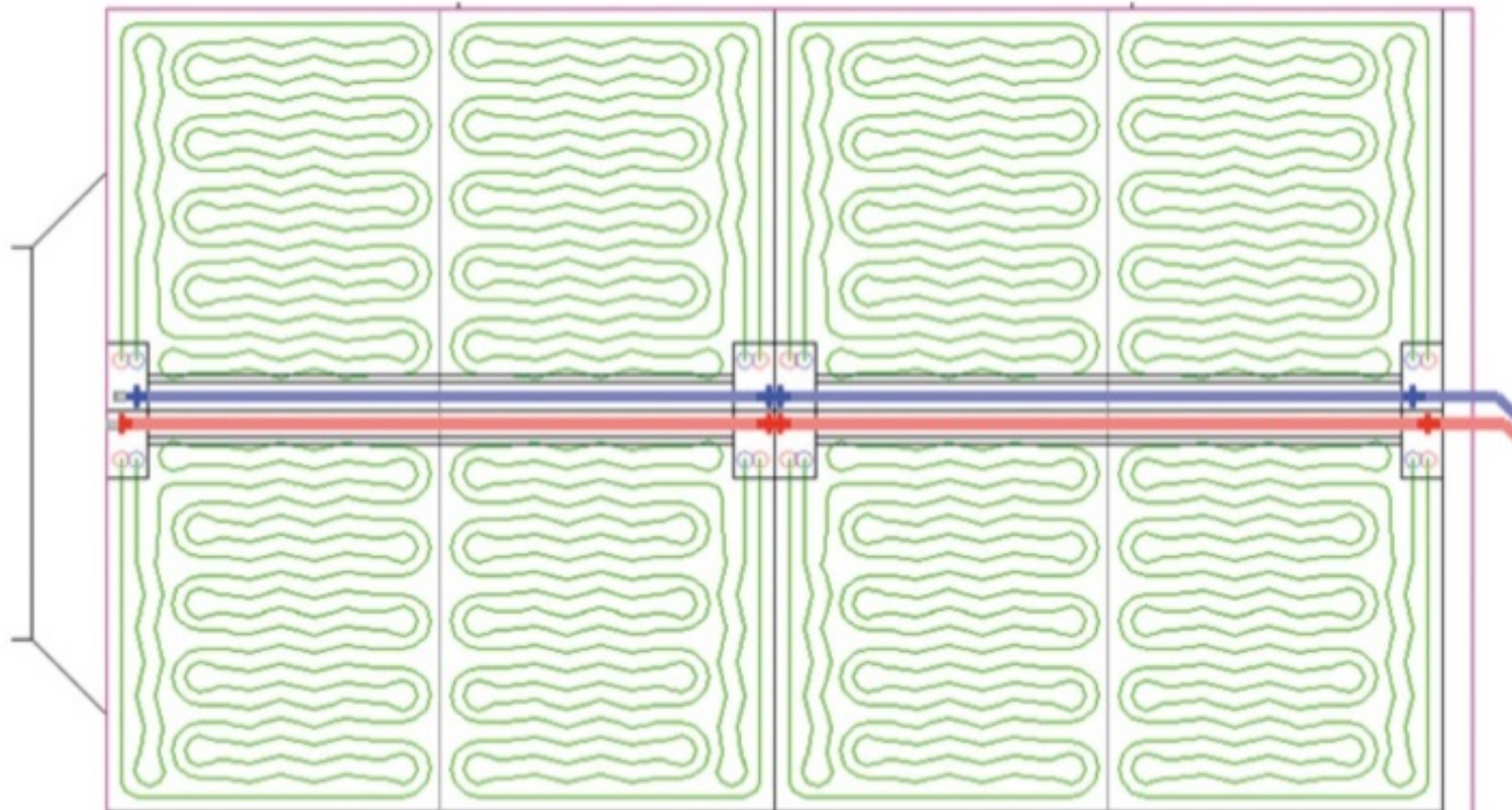

Montage

- Optimale Verlegemöglichkeiten durch maximale Flächennutzung und minimale Verbindungsstellen.
- Optimale Gewerketrennung



Montage

- Flexible Gestaltung auf der Baustelle durch die Trennmöglichkeit der einzelnen Platten.

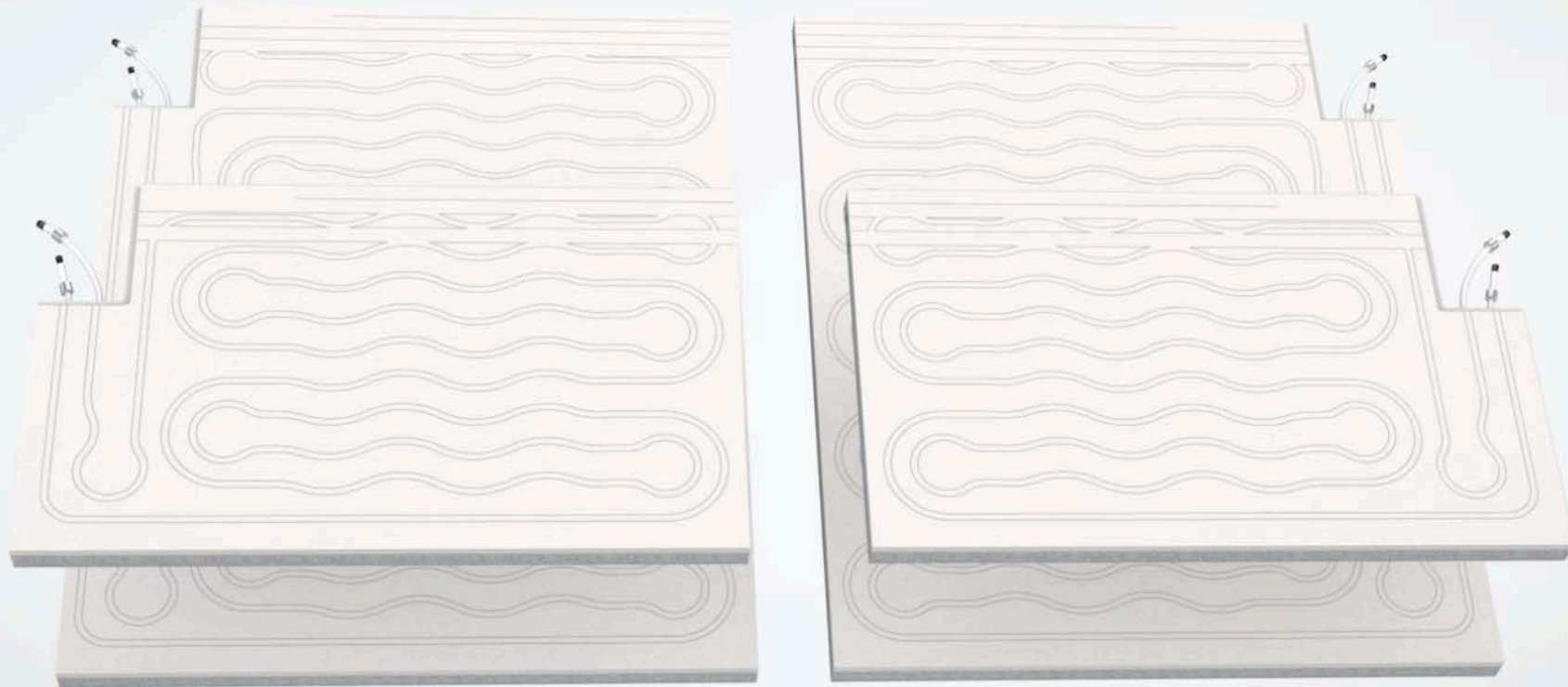

Vergleich: Aktive Flächennutzung

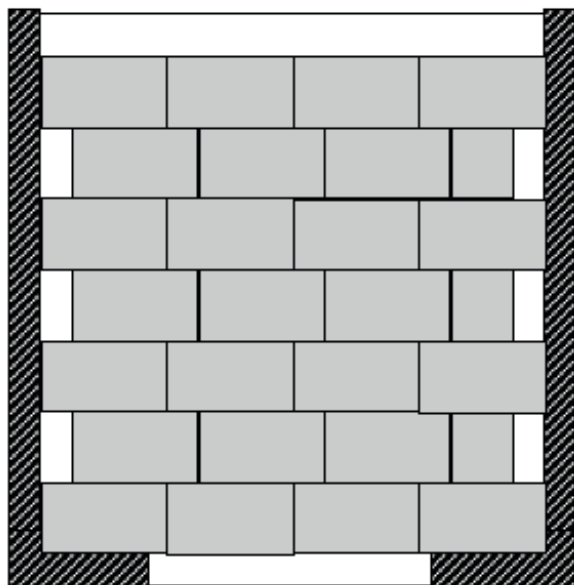

System A

88%

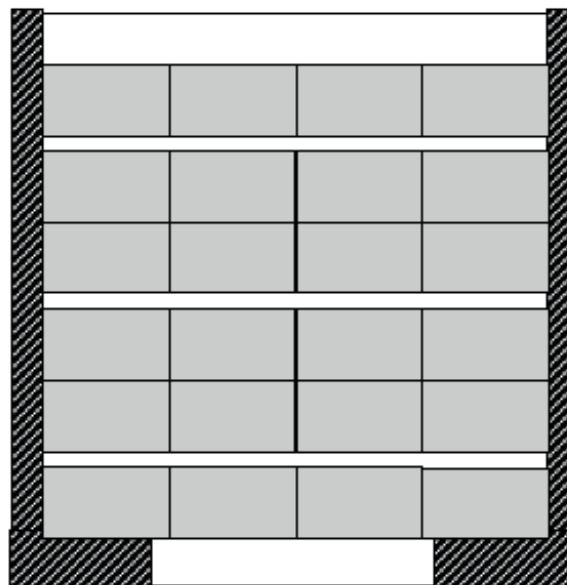

System B

80%

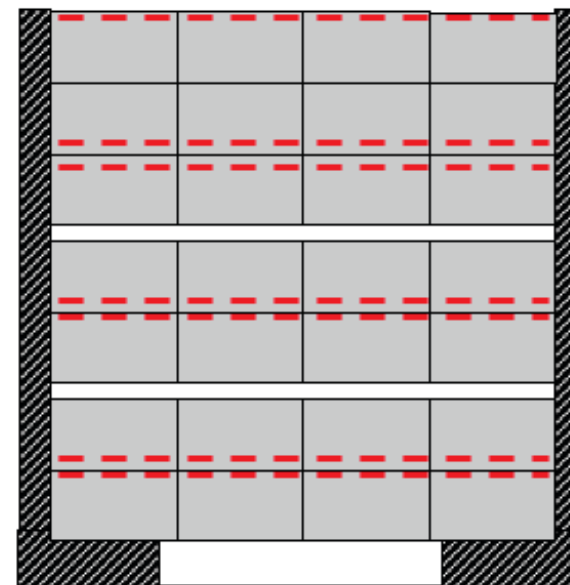

ClouTop®

93%

Vergleich: Anbindeleitung

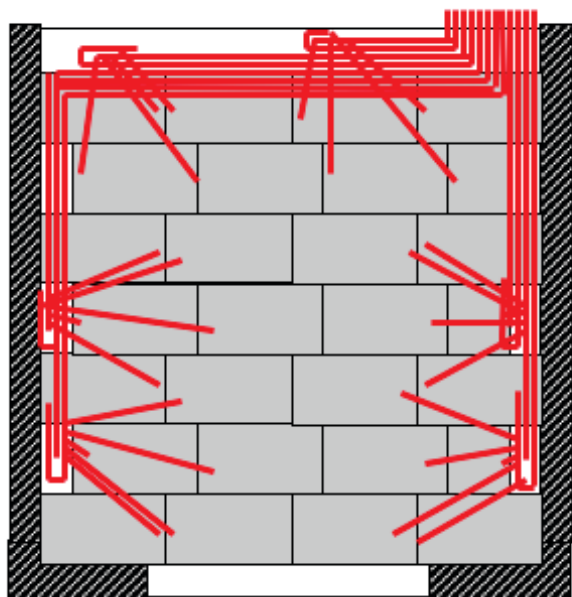

System A

96m

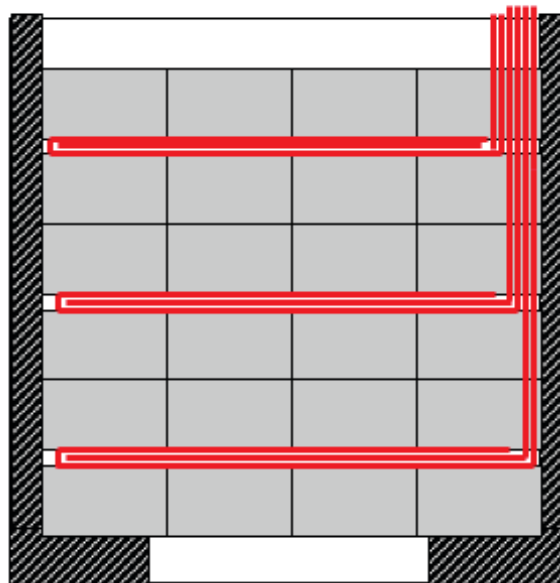

System B

78m

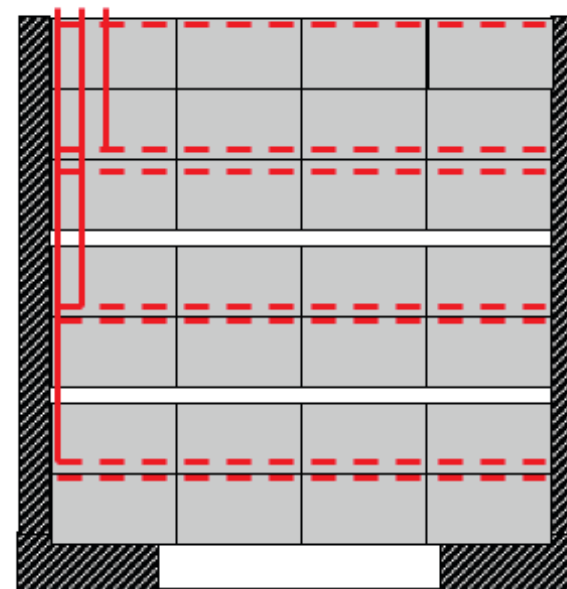

ClouTop®

36m

Deckensysteme

Leonardo 5.5

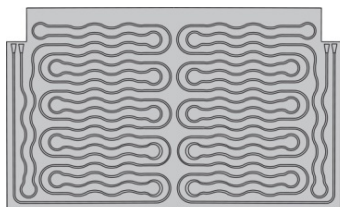
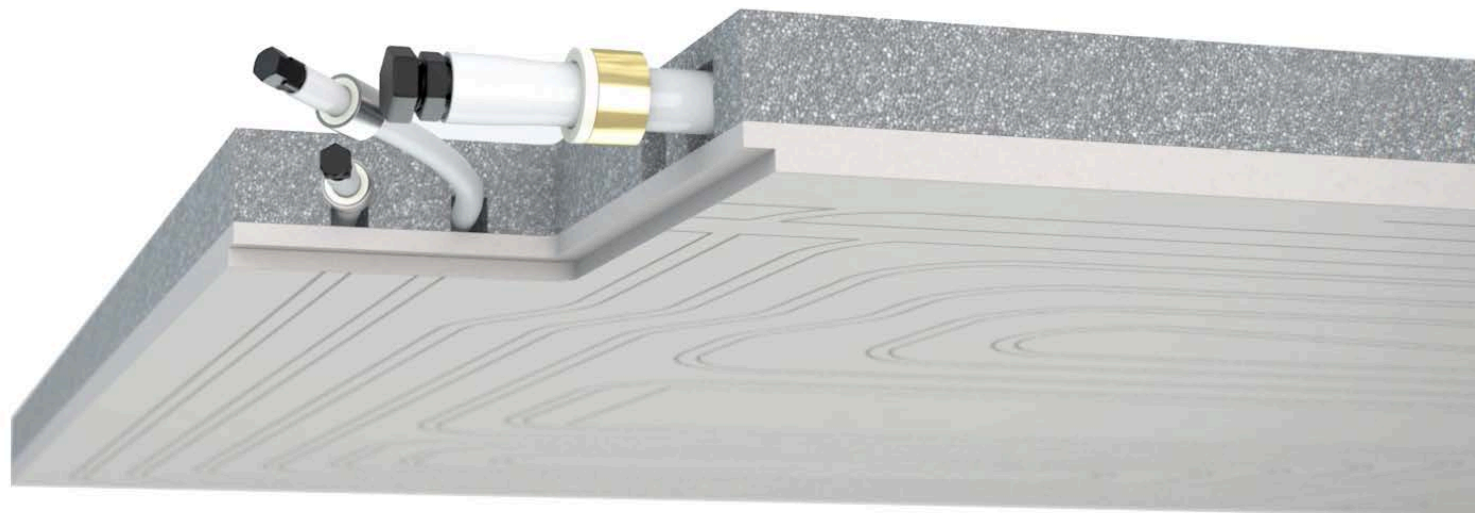

Platte aus EPS mit Graphit + Gipskarton

1200x2000x50 mm

 EPS
 Graphit  2,4 m²  30 kg  20 m

Platte aus EPS mit Graphit + Gipskarton

600x2000x50 mm

 EPS
 Graphit  1,2 m²  15 kg  10 m

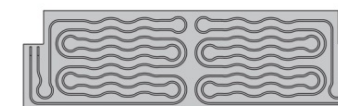

 Ph 75,8 W/m²

 Pc 47,3 W/m²

Leonardo 5.5 Hydro

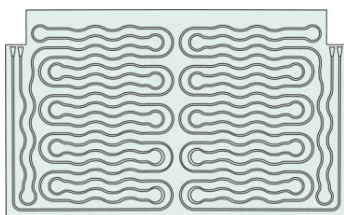
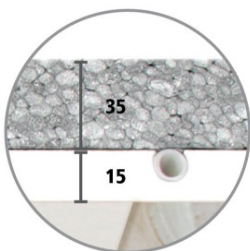
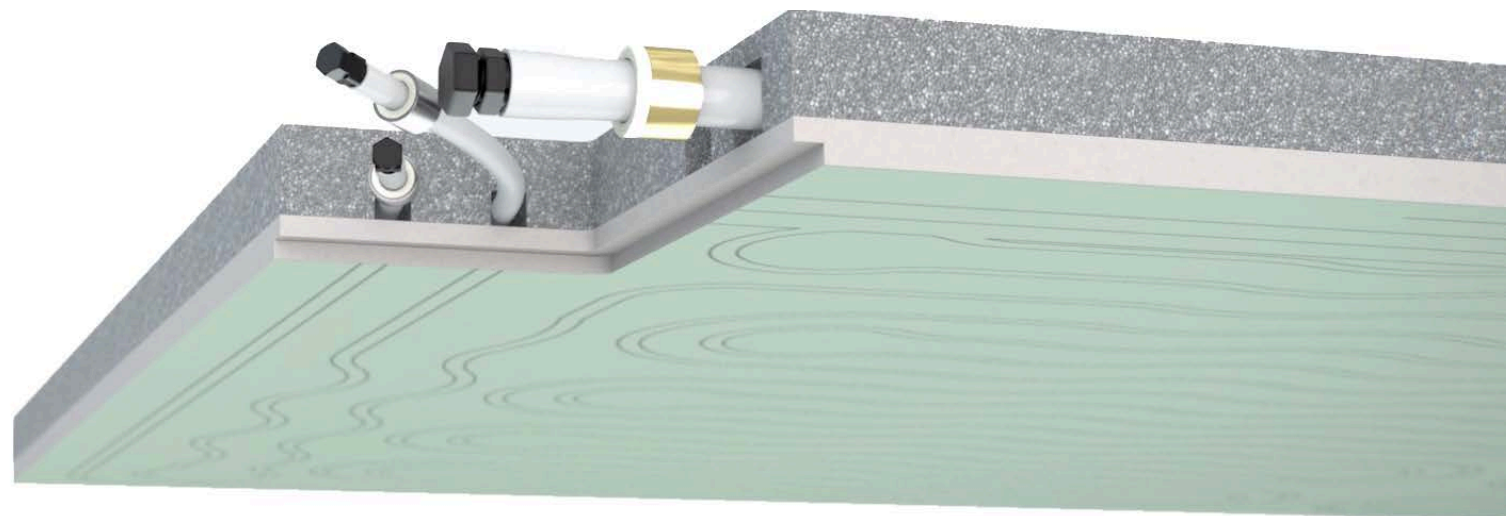

Platte aus EPS mit Graphit + Gipskarton,
feuchtigkeitsbeständig

1200x2000x50 mm

EPS 2,4 m² 30 kg 20 m

Platte aus EPS mit Graphit + Gipskarton,
feuchtigkeitsbeständig

600x2000x50 mm

EPS 1,2 m² 15 kg 10 m

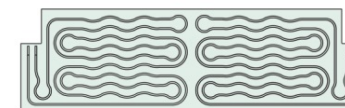

 Ph 75,8 W/m²

 Pc 47,3 W/m²

Leonardo LUX

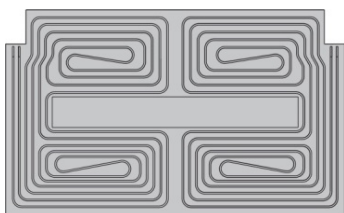
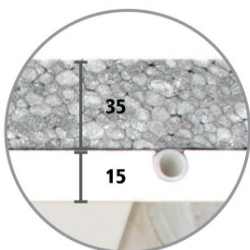
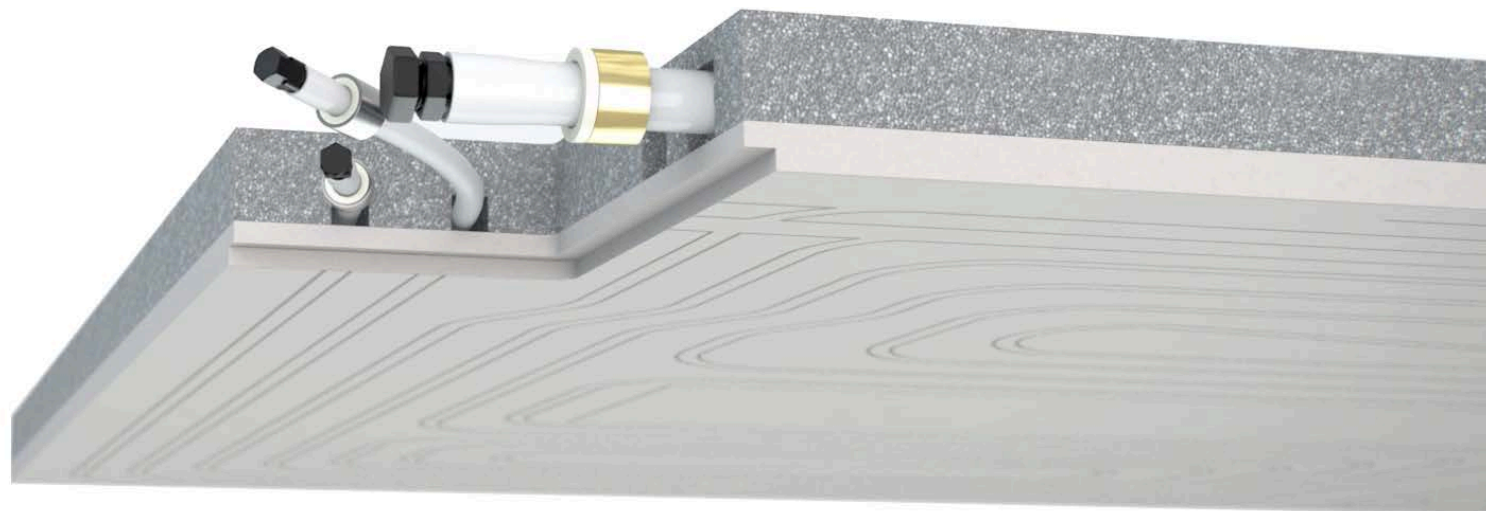

Platte aus EPS mit Graphit + Gipskarton

1200x2000x50 mm

EPS
 Graphit

 2,4 m²
 30 kg
 21,2 m

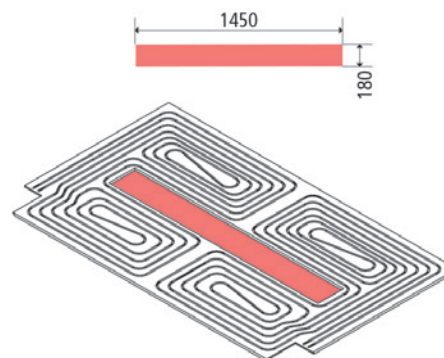

Ph 75,8 W/m²

Pc 47,3 W/m²

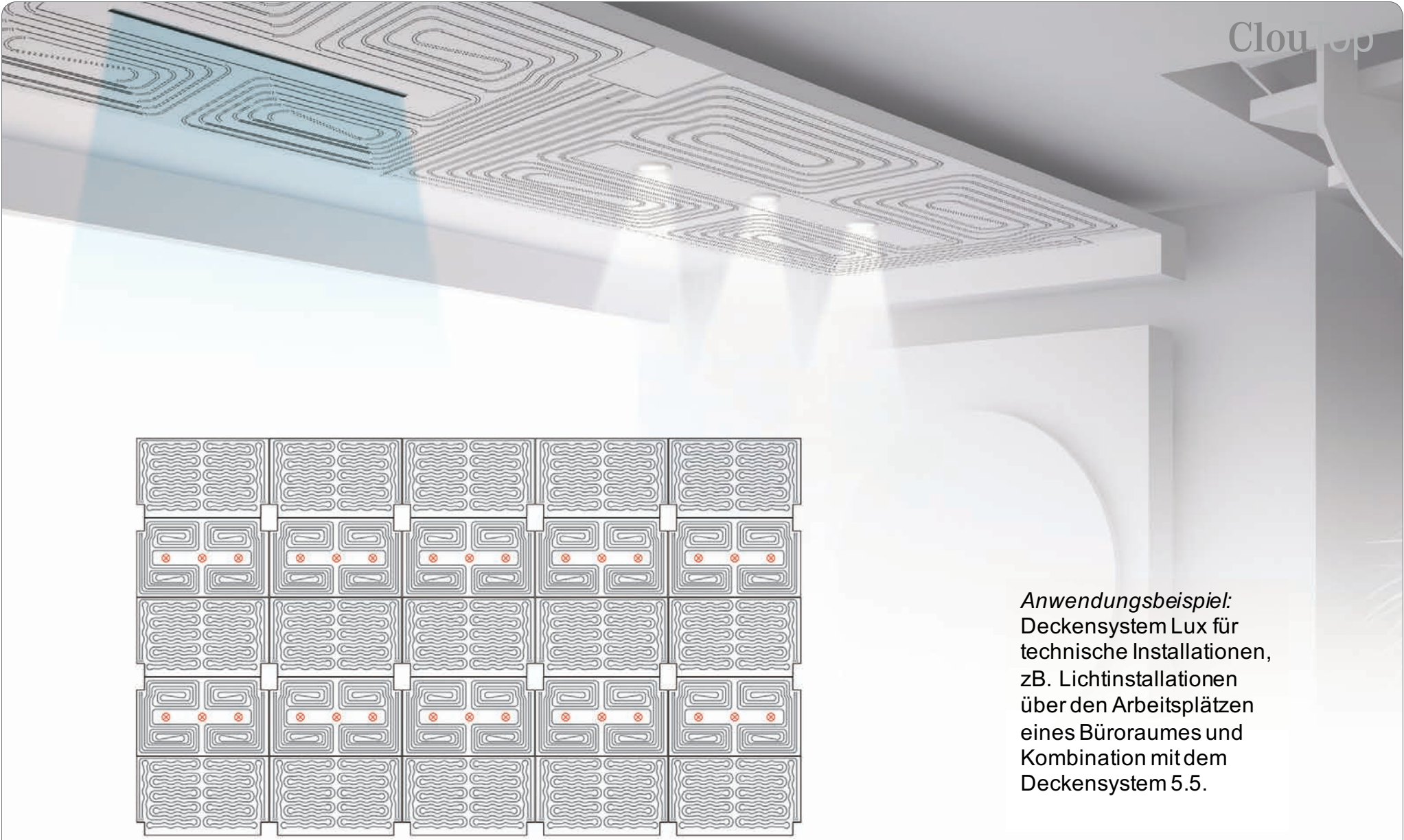

Anwendungsbeispiel:
Deckensystem Lux für
technische Installationen,
zB. Lichtinstallationen
über den Arbeitsplätzen
eines Büroraumes und
Kombination mit dem
Deckensystem 5.5.

Leonardo 10

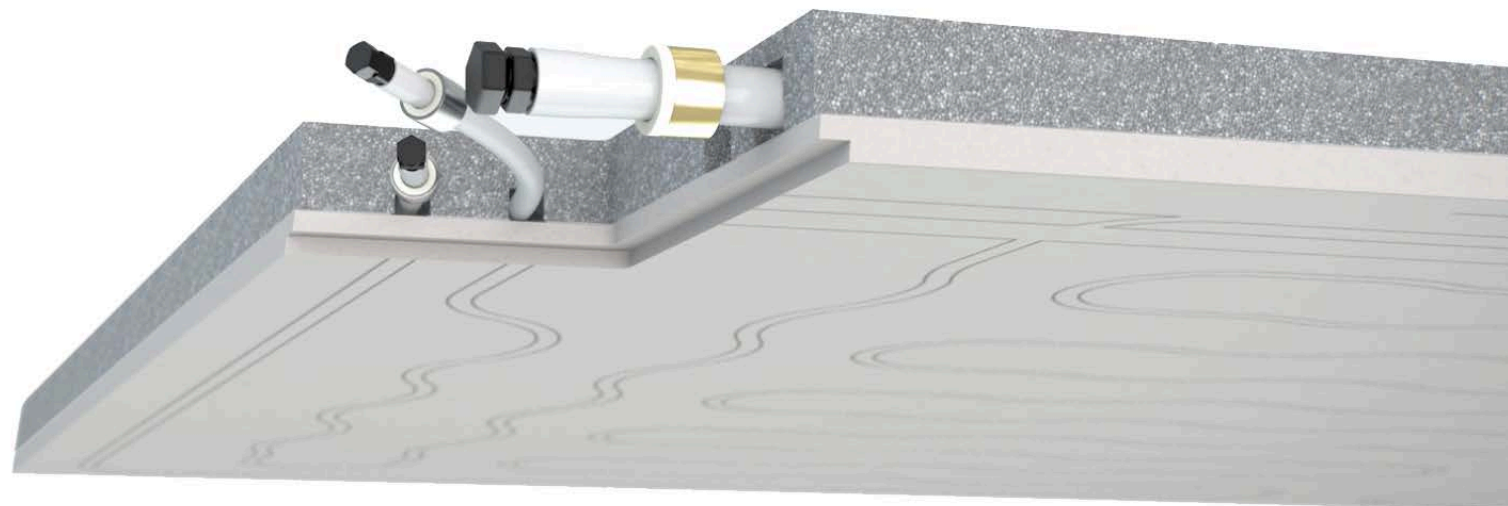
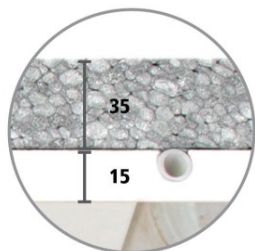

Platte aus EPS mit Graphit + Gipskarton

1200x2000x50 mm



 2,4 m²
 30 kg
  20 m

Platte aus EPS mit Graphit + Gipskarton

600x2000x50 mm

 1,2 m²
 15 kg
  10 m

 Ph 55,9 W/m²

 Pc 32,8 W/m²

Leonardo 3.5

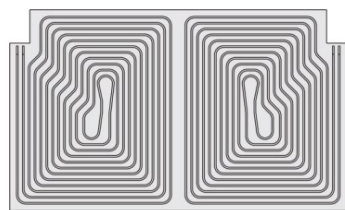
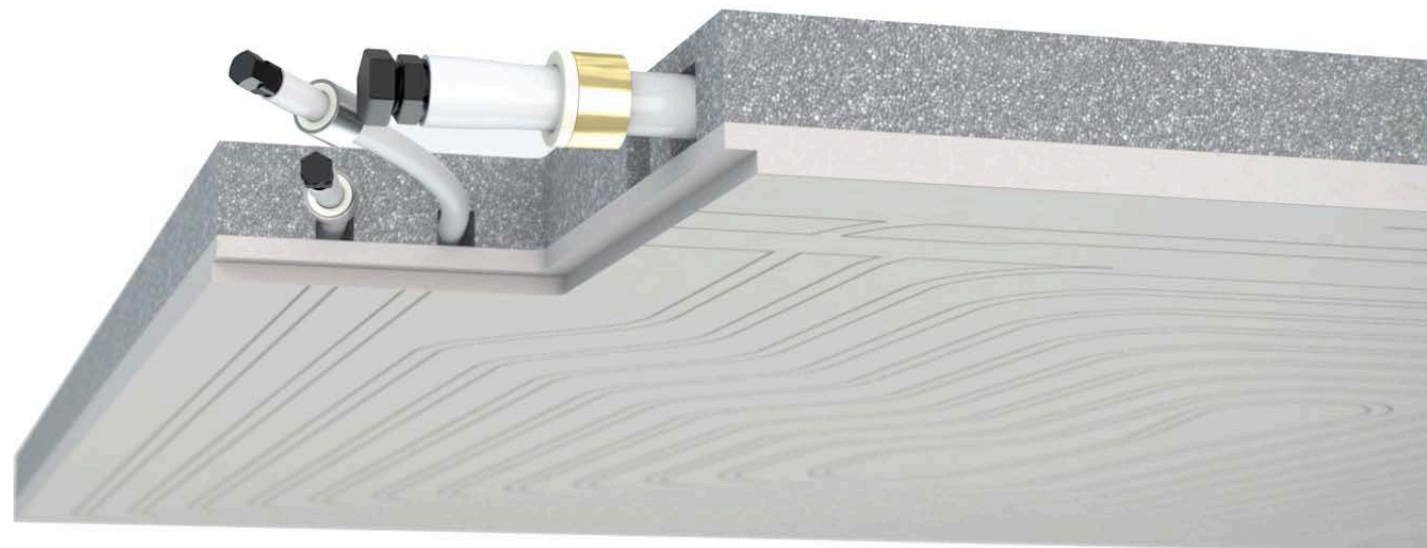
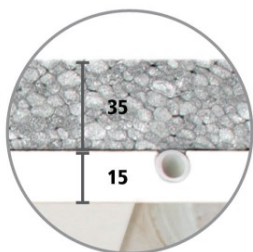

Platte aus EPS mit Graphit + Gipskarton

1200x2000x50 mm

EPS
 Graphit
 2,4 m²
 40 kg
 28 m

Platte aus EPS mit Graphit + Gipskarton

600x2000x50 mm

EPS
 Graphit
 1,2 m²
 20 kg
 13 m

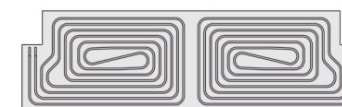

Ph 90,3 W/m²

Pc 60,0 W/m²

Leonardo 3.5 High Performance

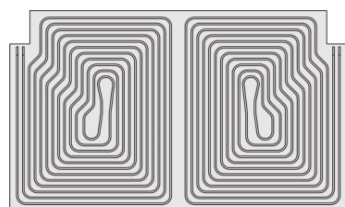
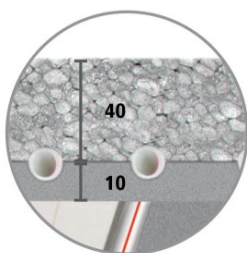
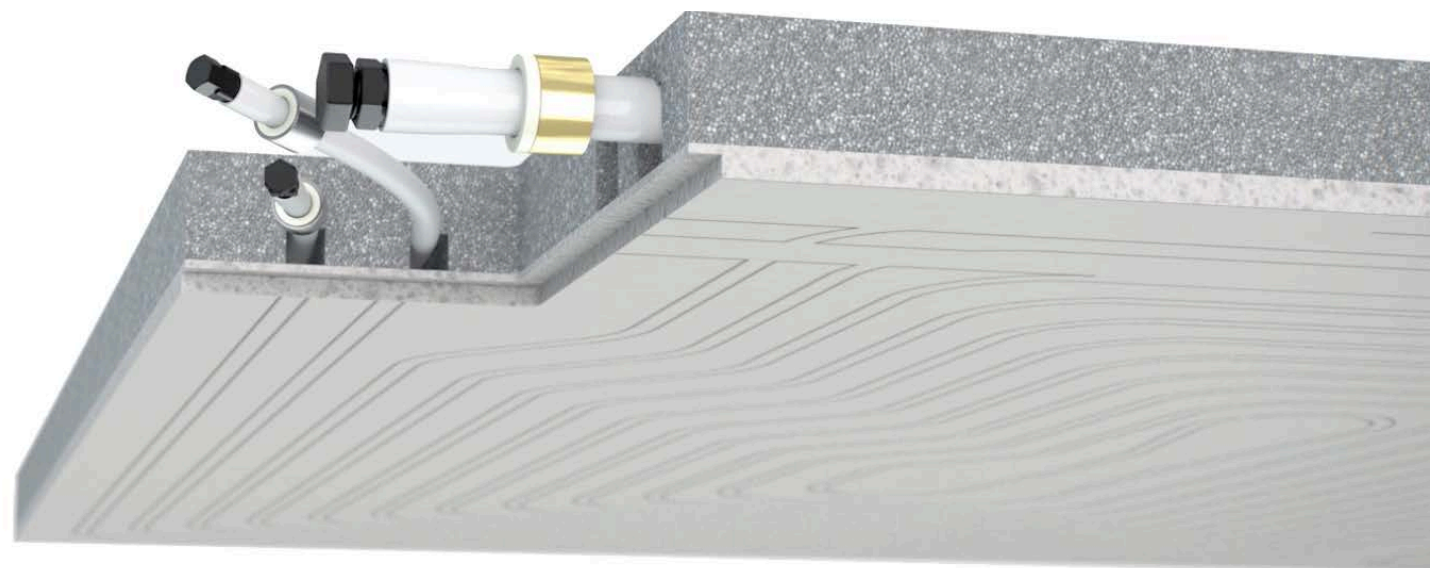

EPS-Platte mit Graphit +
Gipskarton mit Graphit

1200x2000x50 mm

EPS
 Graphit
 2,4 m²
 40 kg
 28 m

EPS-Platte mit Graphit +
Gipskarton mit Graphit

600x2000x50 mm

EPS
 Graphit
 1,2 m²
 20 kg
 13 m

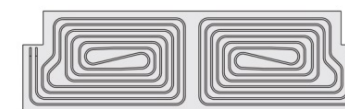

Ph 101,3 W/m²

Pc 74,8 W/m²

Leonardo RF Fire resistant

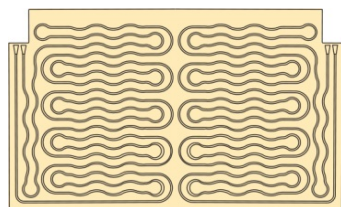
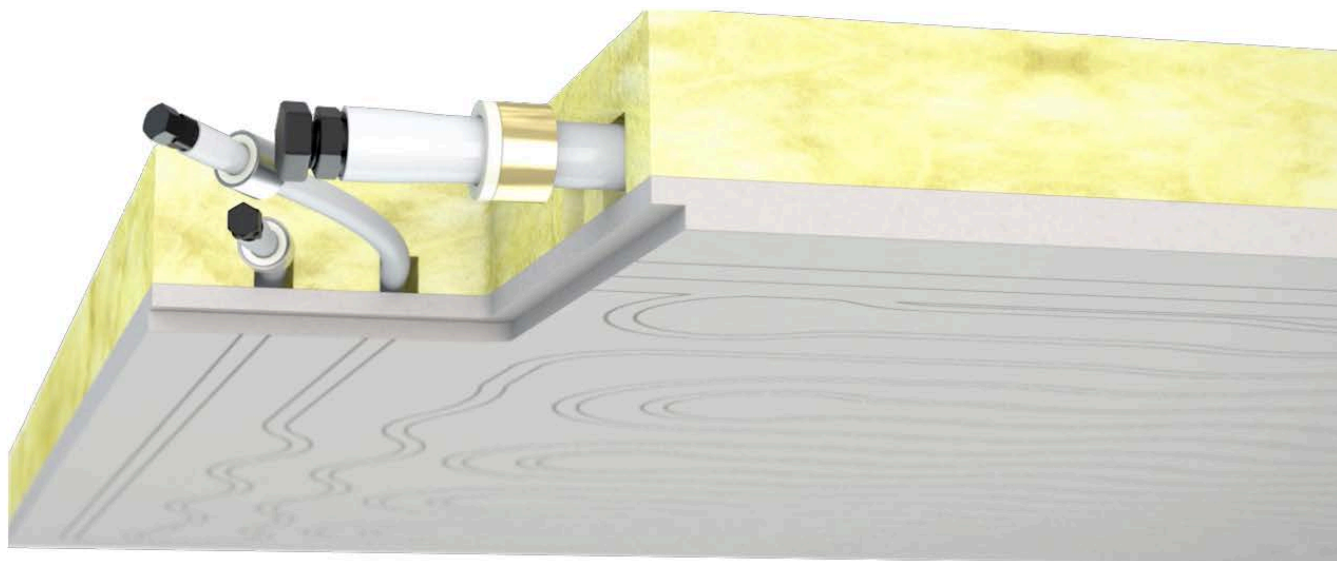
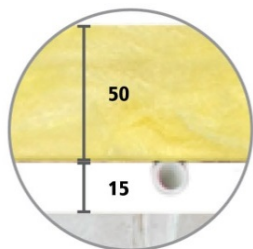

Platte aus Glasfasern + Gipskarton

1200x2000x65 mm

Glasfaser

 2,4 m²

 43 kg

 20 m

Platte aus Glasfasern + Gipskarton

600x2000x65 mm

Glasfaser

 2,4 m²

 21,5 kg

 10 m

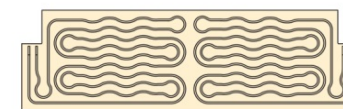

Ph 55,9 W/m²

Pc 32,8 W/m²

Maximale Platten pro Anschluss

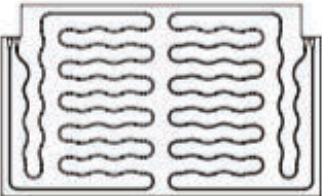
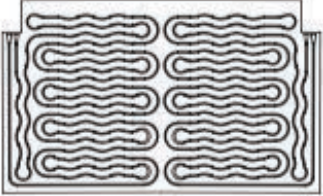
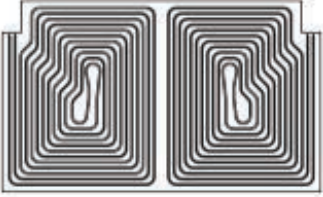
	Max. Platten/Anschluss	Kreise/Anschluss	M2/Anschluss
	10	8	16
	5,5	6	12
	3,5	4	8

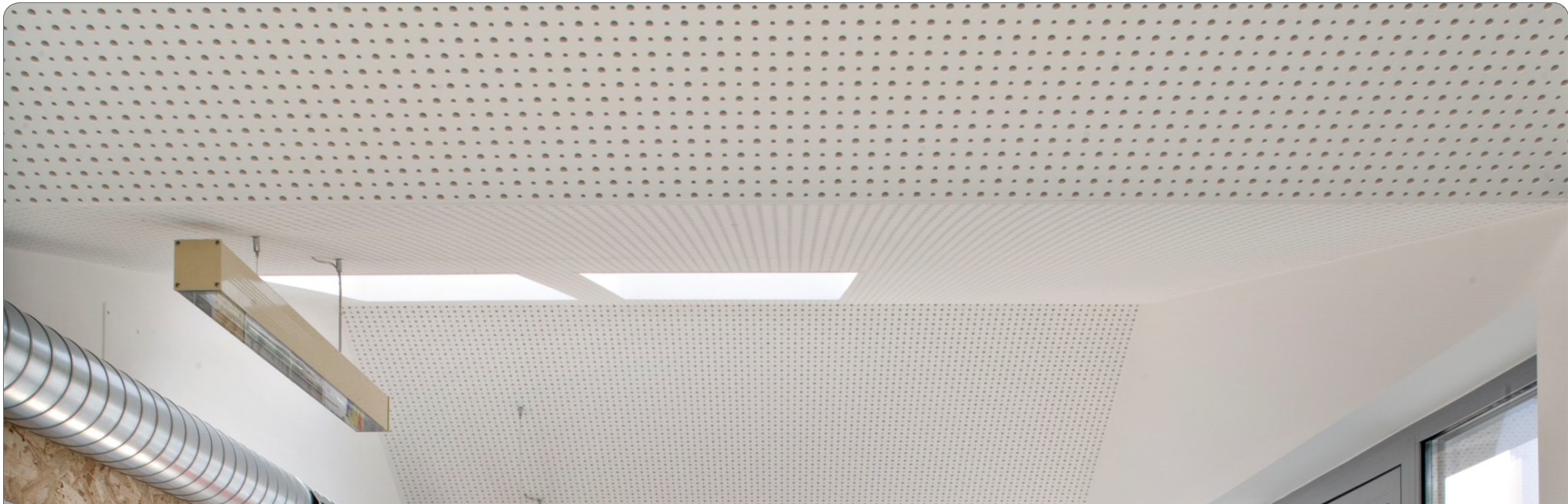

Saubere Luft

Ein besonderes Merkmal der Platte ist ihr Kern aus Gips und Zeolith, einem natürlich vorkommenden Stein mit Mikroporen. Dadurch kann die Konzentration der Schmutzstoffe in der Luft (Zigarettenrauch, Küchengerüche, Benzol, aromatische Kohlenwasserstoffe usw.) gesenkt werden.

Ribassamento: $a = 200 \text{ mm}$; $b = 60 \text{ mm}$

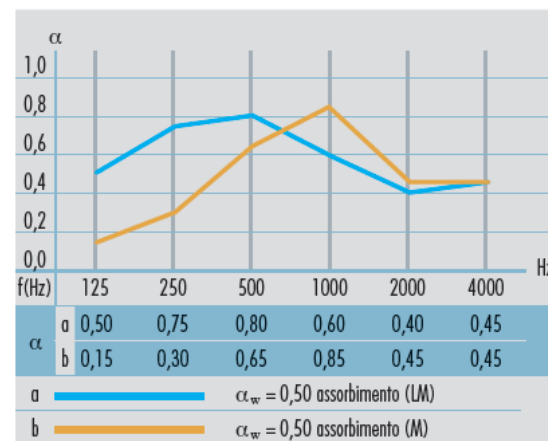

Doppelte Akustikplatte, um eine optimale Akustik zu gewährleisten ohne die Optik zu beeinträchtigen.

Eine Aufliegende Isolierung, ermöglicht außerdem eine weitere Verbesserung der Absorption, und eine Brandschutzgerechte Isolierung.

Akustik-System

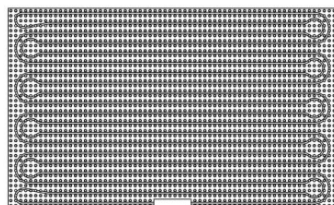

Doppelakustikplatte aus Gipskarton*

1200x1980x25 mm

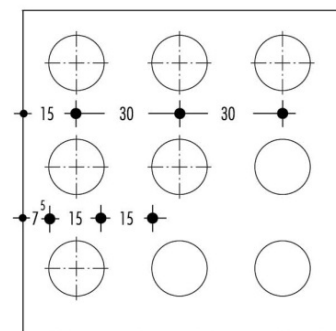

 Ph 70,2 W/m²

 Pc 42,3 W/m²

Akustik-System HP High Performance

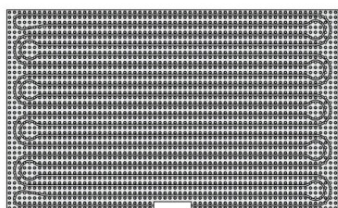

2 Gipskartonakustikplatte* und Graphit

2000x1980x22,5 mm

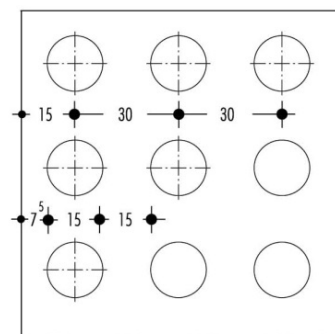

 Ph 80,0 W/m²

 Pc 50,0 W/m²

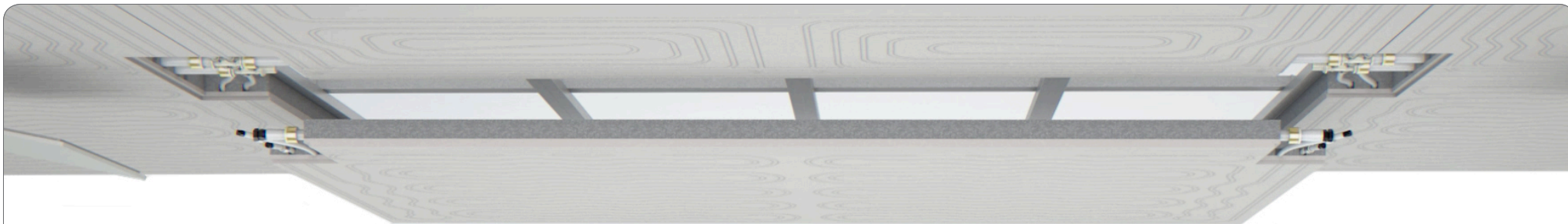

MONTAGE UND INSTALLATION

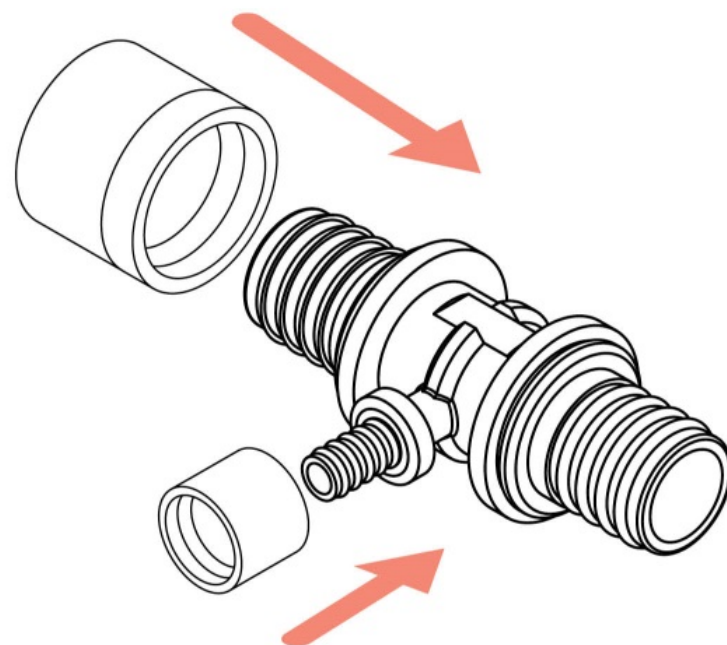

→ Befestigung auf Standard-Profilstruktur (z.B. KNAUF).

Für eine einfache Montage wird eine Aufbauhöhe von mindestens 15 cm empfohlen.

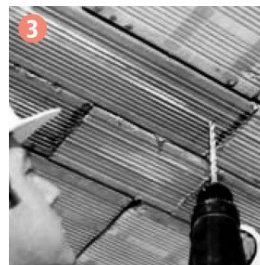

Profilkonstruktion - Lattung

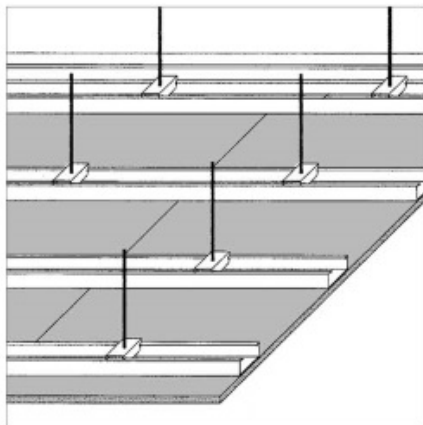

D111

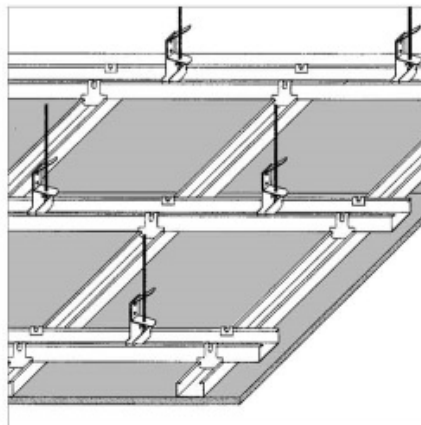

D112

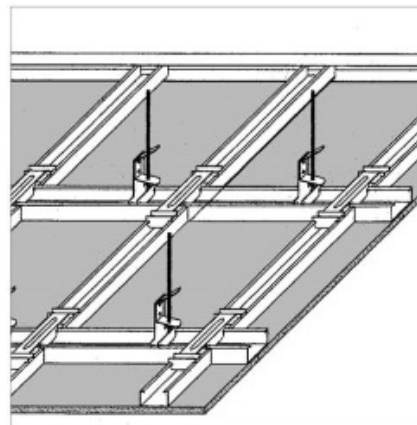

D113

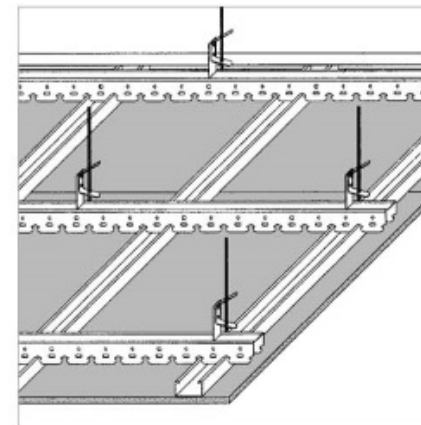

D114

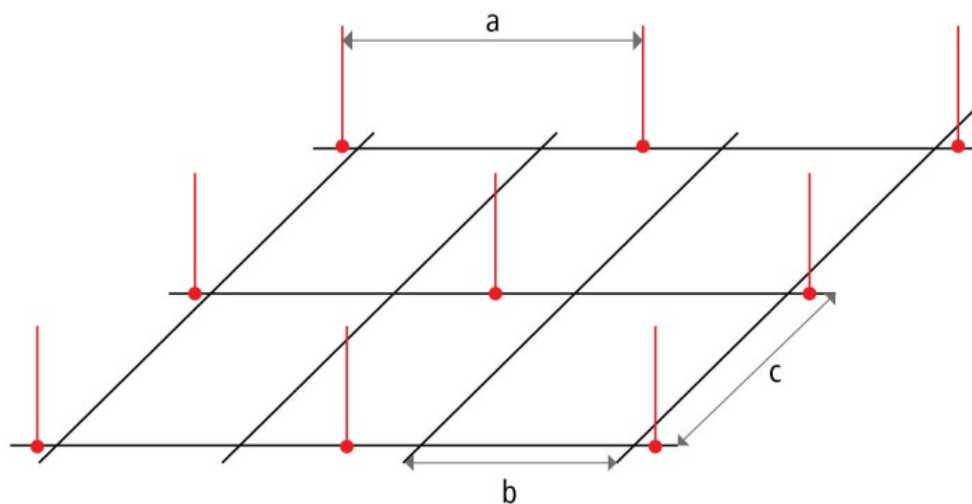

	a	b	c
D111	50	-	50
D112	75	50	100
D113	65	50	120
D114	75	50	100



In Sonderfällen und mit spezifischen Vorkehrungen kann die Aufbauhöhe bedeutend reduziert werden.

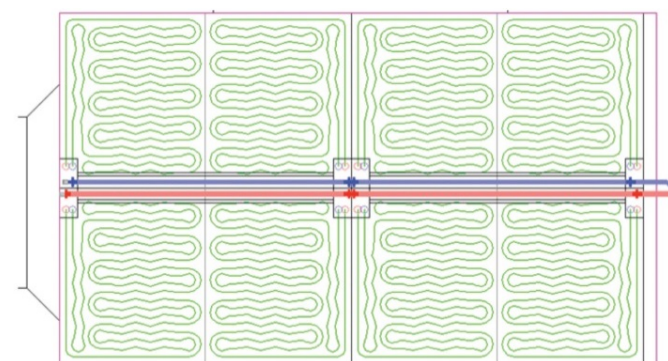

Abschlussdeckel

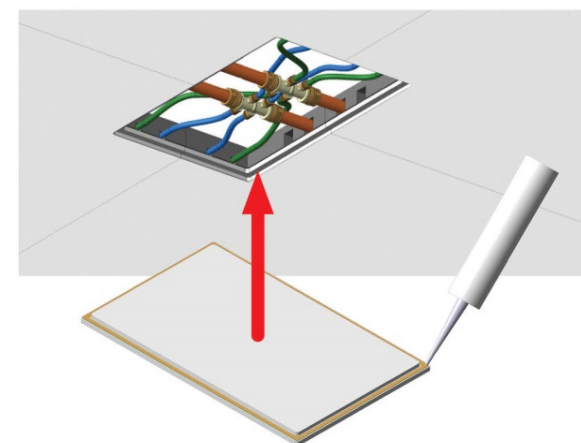

Montage Akustikplatten

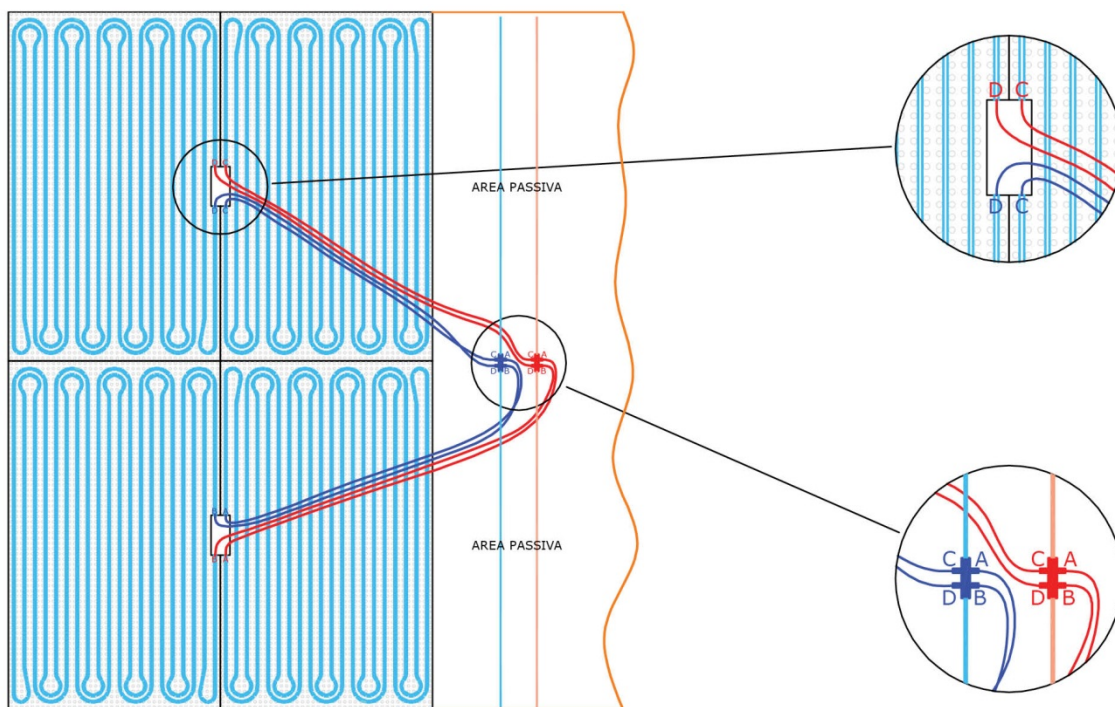

Achsabstand Lattung: 330 mm
 Empfehlung: Knauf D112 oder D114
 C-Profile 60 mm

Die Verbindung der einzelnen Systemplatten an die Anbindeleitung erfolgt in Gruppen.

Dies ermöglicht die Montage von **großen aktiven Flächen**.

Durch diese Anbindelösung kann die Aufbauhöhe ober der Platte stark reduziert werden.

Montage Akustikplatten

Isolierplatten aus
Glasfaser in PE Folie
600 x 600 mm

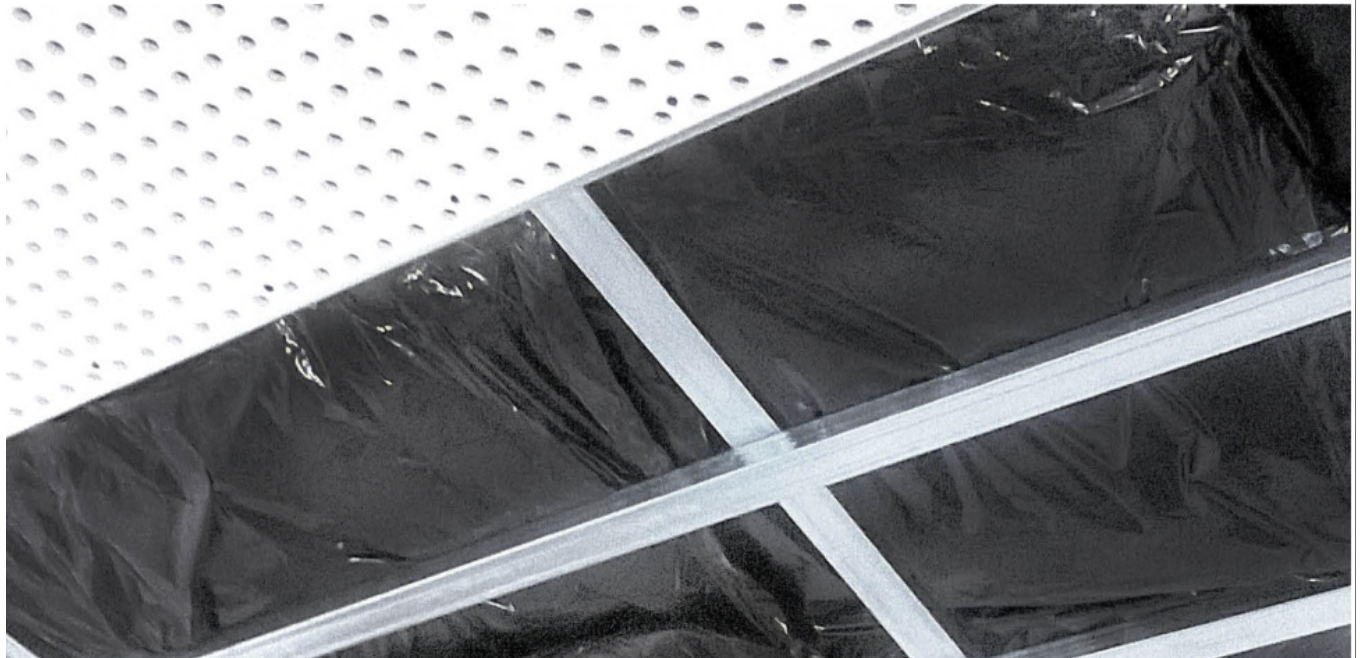

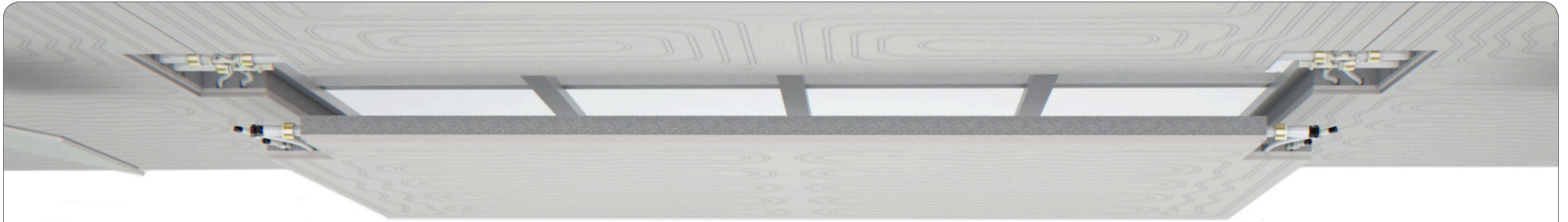



NORMEN UND LEISTUNGSPRÜFUNGEN

WSP*lab*

Leistungsprüfungen

- 
 Leistungsprüfung des Leonardo-Deckensystems nach prEN 14037-2 **in Heizung**
- 
 Leistungsprüfung des Leonardo-Deckensystems nach EN 14240 **in Kühlung**



WSPlab

Geprüft im WSP Lab in Stuttgart
(nach DIN prEN14037)

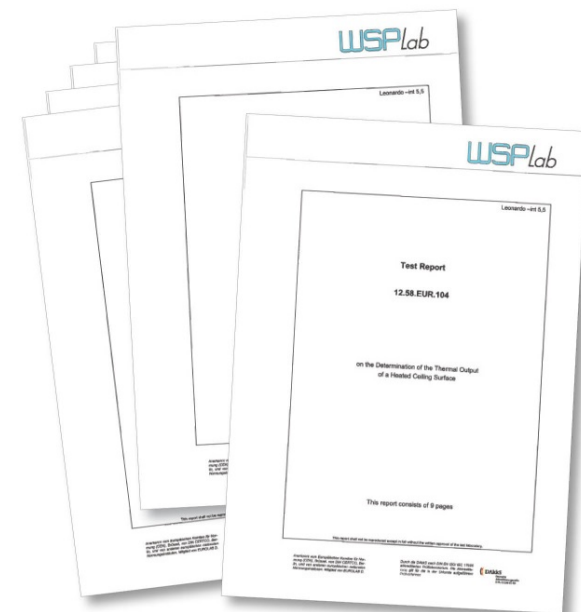

Prüfungen im WSPLab in Stuttgart

Beispiel Leonardo 10

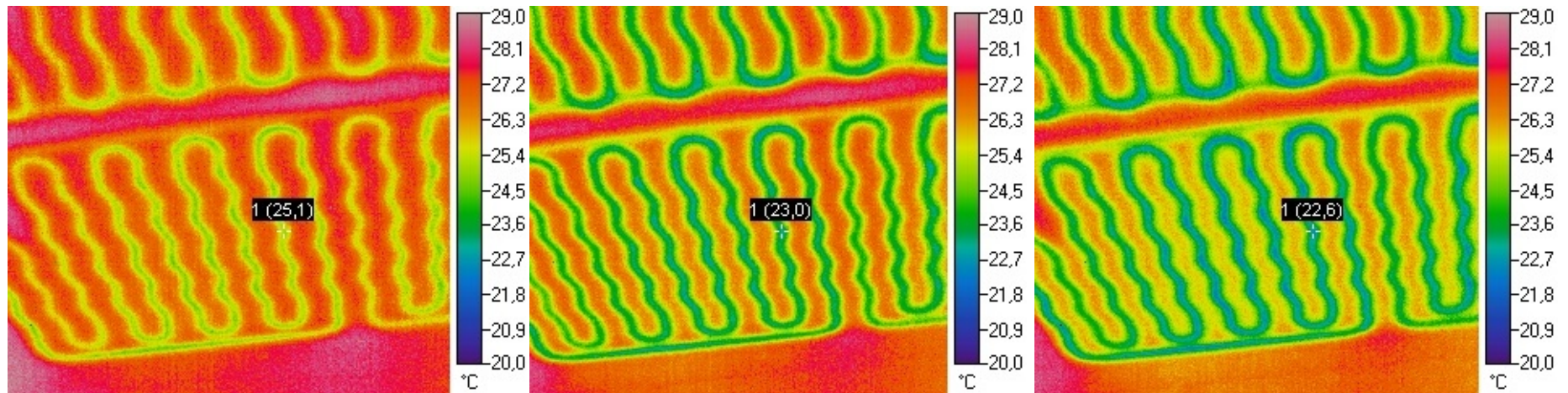

Anfang der Kühlphase

nach 20 min.

nach 60 min

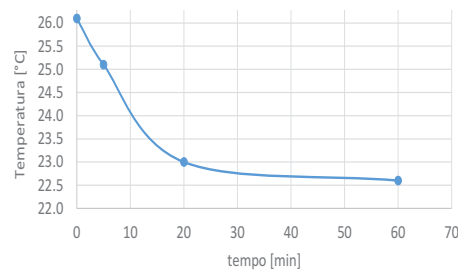

Leistungsdaten



EN 14240_2005
 $\Delta\theta_{st} = 8K$

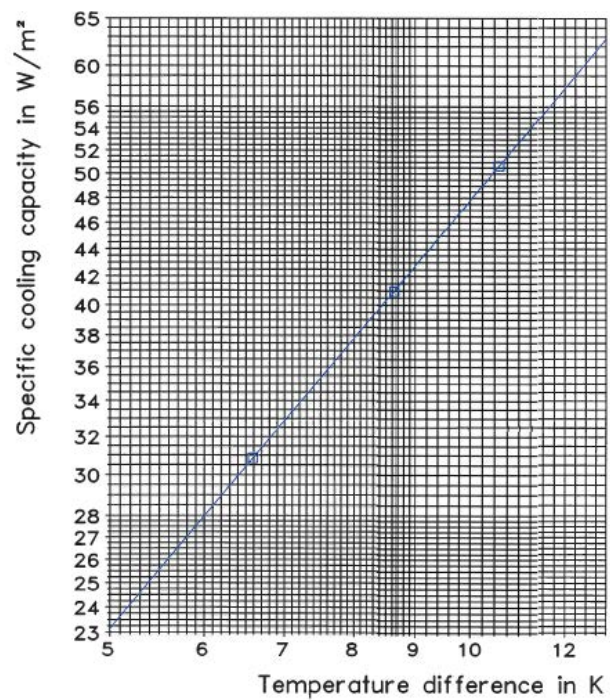

prEN 14037_2011
 $\Delta\theta_{st} = 15K$

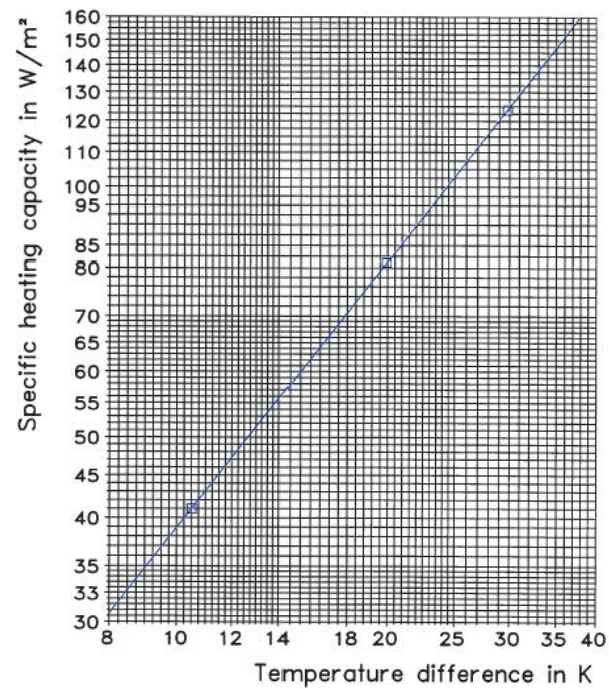



Heizung

Wärmeleistungsverlaufkurven aus den Zertifikaten gemäß prEN 14037-5:2011 beim Heizen

WSP Lab

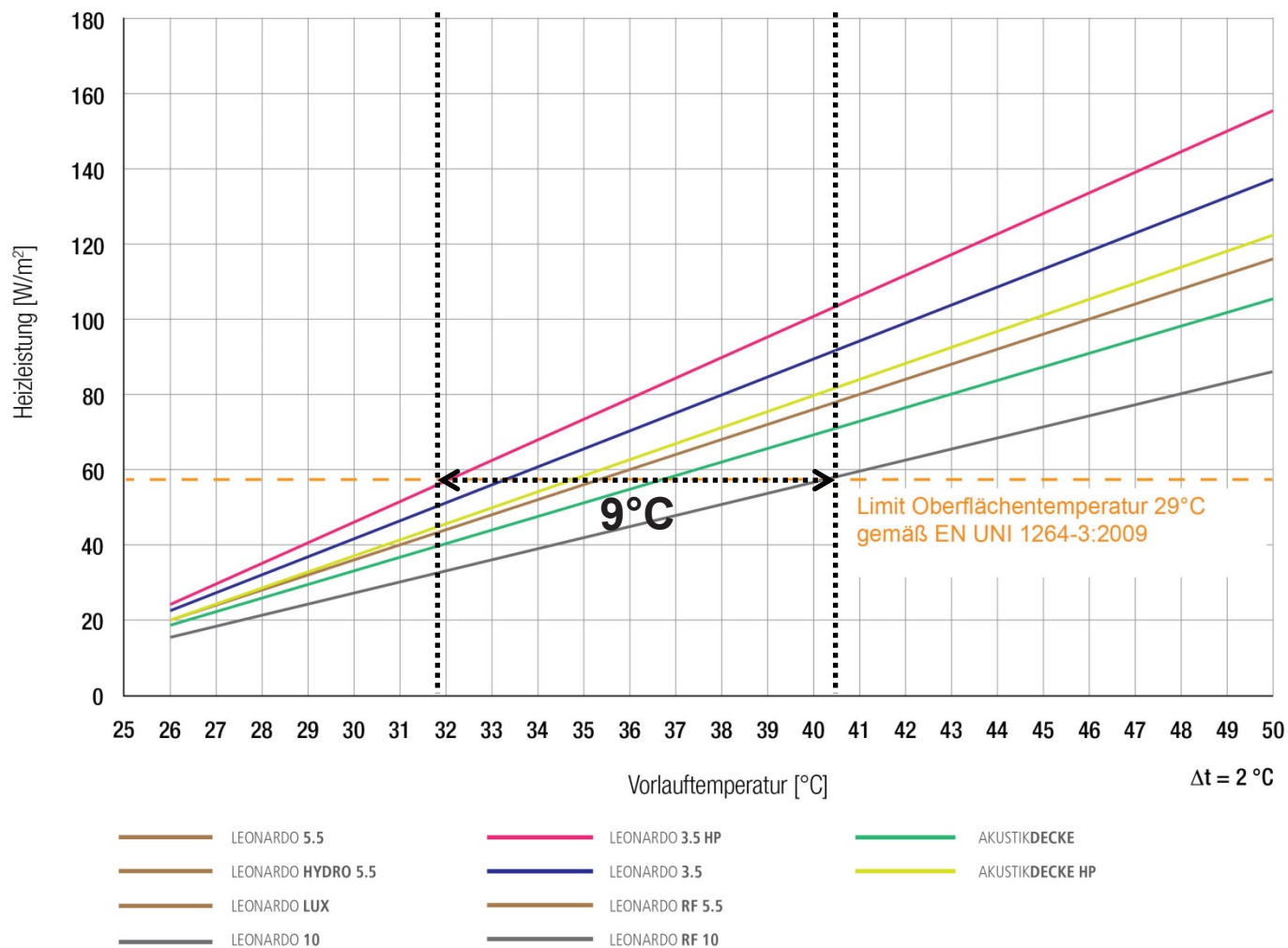



Kühlung

Wärmeleistungsverlaufkurven aus den Zertifikaten gemäß UNI EN 14240:2005 beim Kühlen

WSP_{lab}

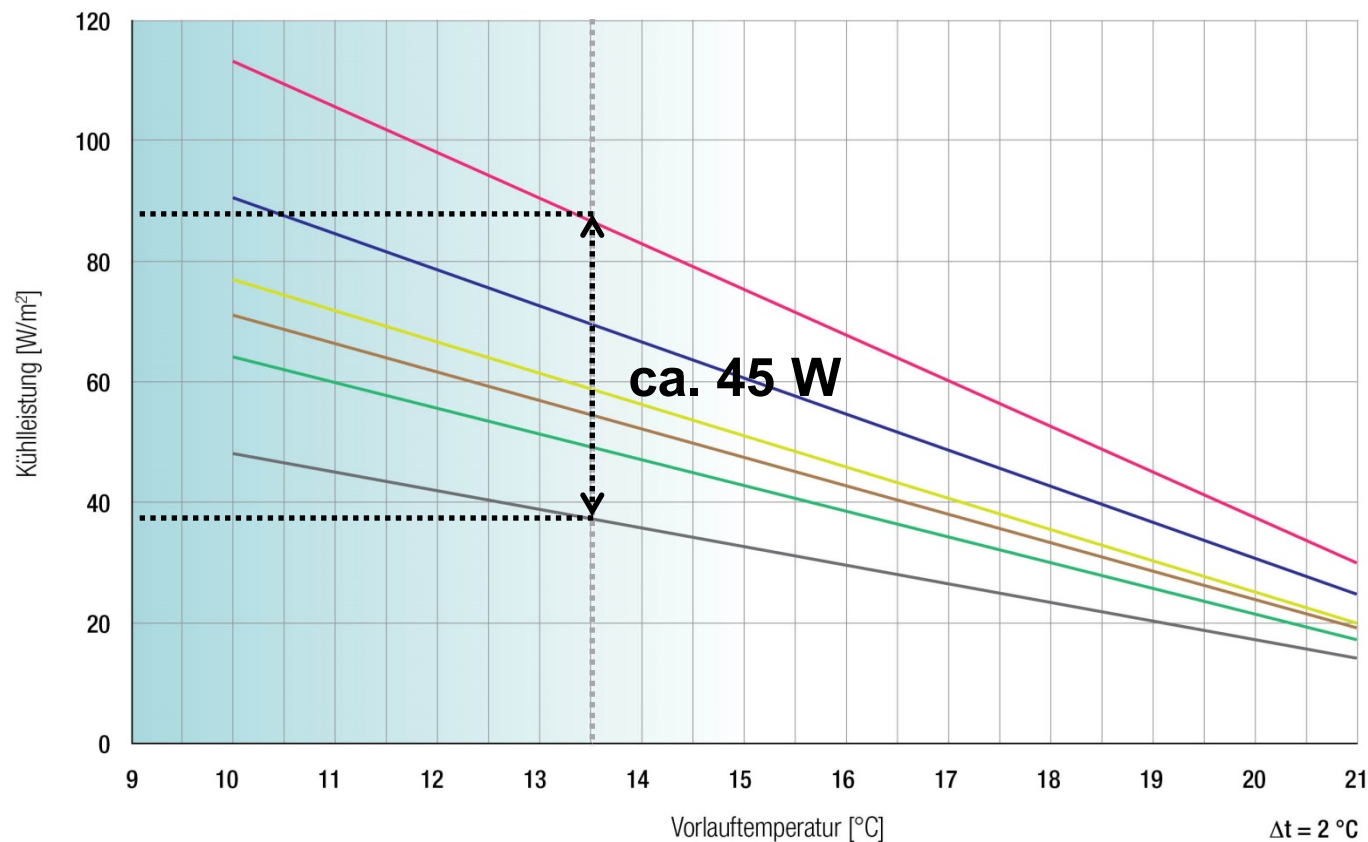

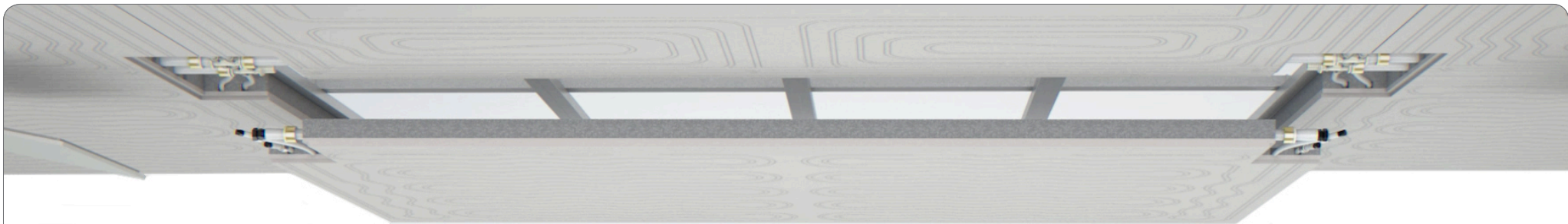

BERECHNUNG UND PLANUNG

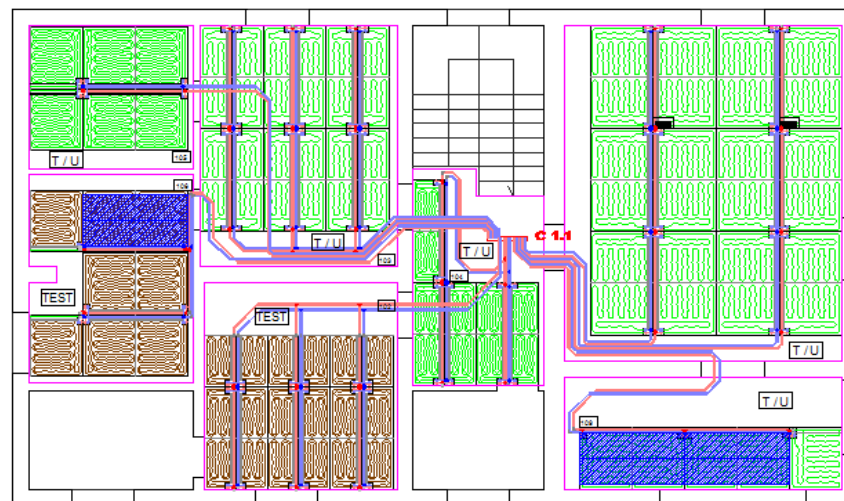

Software HT2000 v.8.5 mit dem System Leonardo

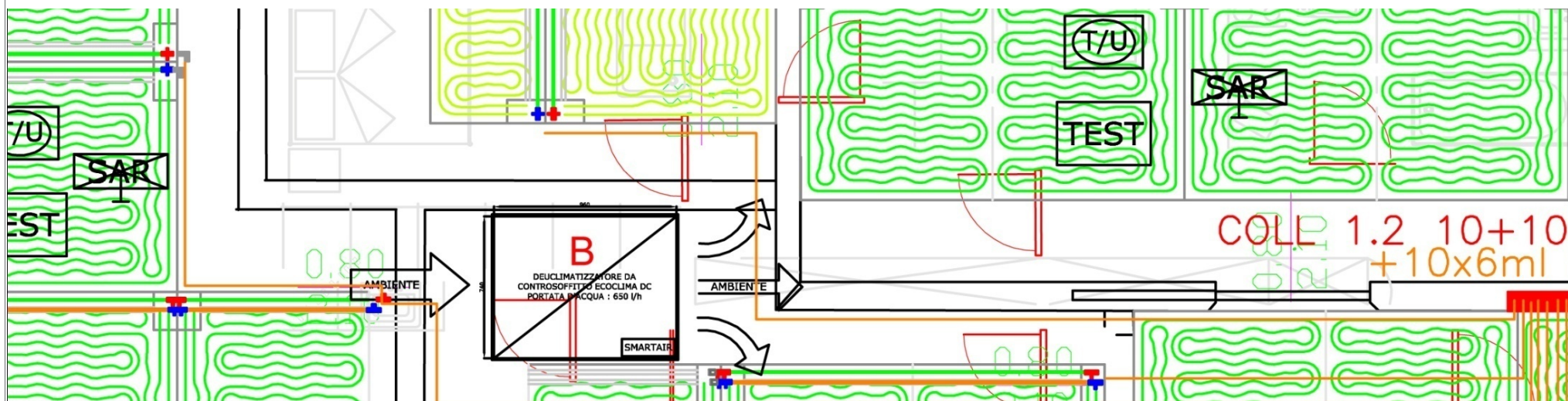

- Anzahl und Art der Systempanele;
- Druckverlust für die Anbindeleitungen, um eine optimale Funktion zu gewährleisten;
- Vorlauftemperaturen zur idealen Nutzung (bei 29°C max. Oberflächentemperatur);
- Minimale Vorlauftemperatur, um bei Kühlfunktion die Oberflächentaubildung zu vermeiden.

Software HT2000 v.8.5 mit dem System Leonardo

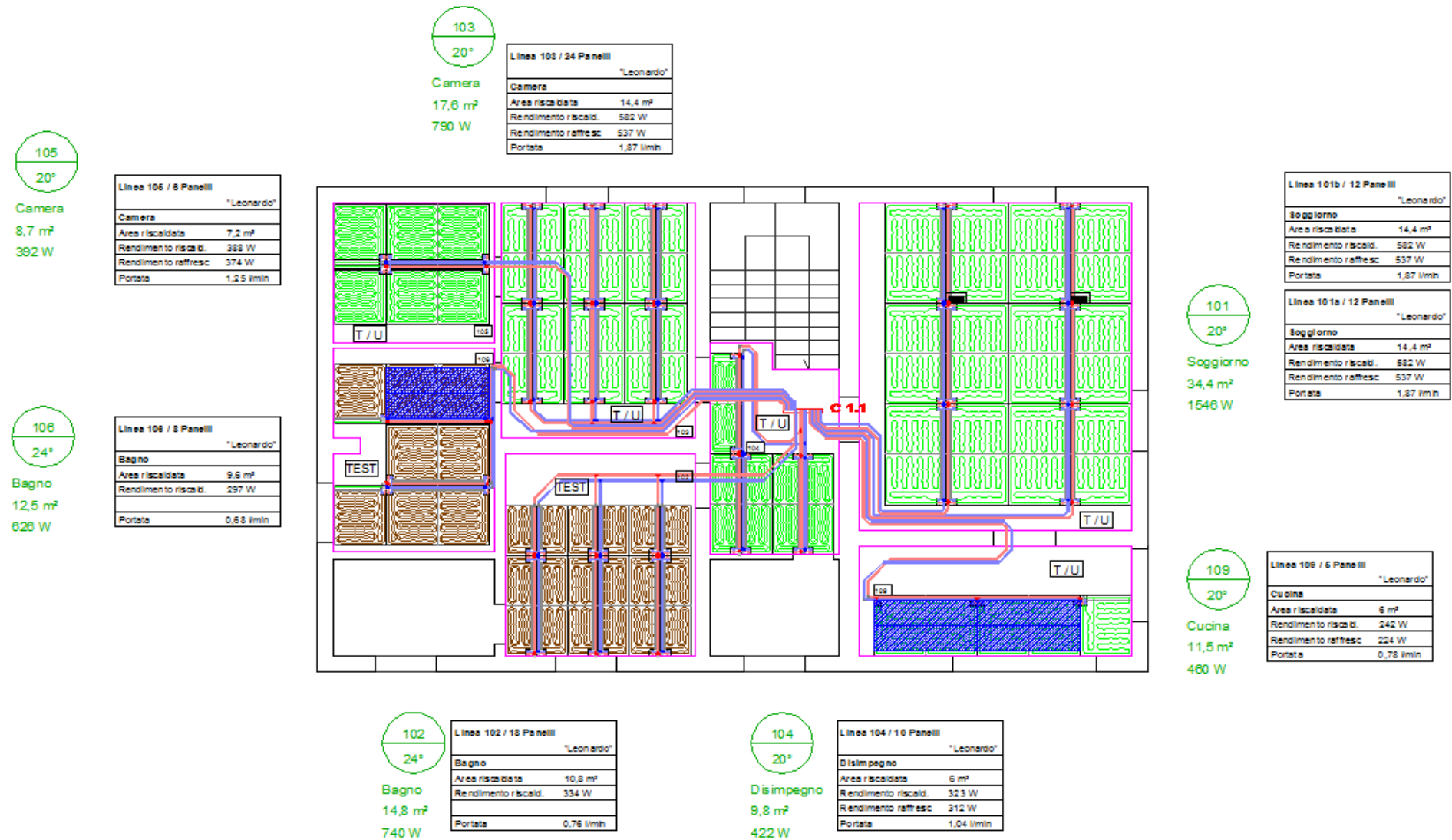



ClouSet®

FLÄCHENSYSTEME

www.clouset.de